

BEST PRACTICE ACCESSIBILITY GUIDELINES IN TOURISM AND CULTURE



These guidelines are intended for tourism and catering businesses, cultural institutions, such as museums, theatres, cinemas, concert halls – to be used as a guide of good accessibility practices.

The guidelines cover main functional requirements, however, more detailed information is available in the national standards, i.e. in Latvia:

- LVS CEN/TR 17621:2021 “Accessibility and usability of the construction environment. Criteria and specifications of technical characteristics”
- LVS EN 17210:2021 L “Accessibility and usability of the construction environment. Functional requirements”

When planning the design of constructions, premises and services, the different functional requirements of people should be taken into account. The design must be created in a way to compensate for people’s sensory (visual, hearing), movement and cognitive (thinking) impairments, as well as limited mobility, such as pushing baby carriages, heavy bags.

Interreg



**Co-funded by
the European Union**

Estonia – Latvia

Design requirements

VISUAL IMPAIRMENT

- Different ways of transferring information, using audios, tactiles.
- Tactile control options (e.g., buttons, remote controls with buttons etc., as people with visual impairment are unable to use touch screens).
- Compliance with appropriate size, contrast, shape, lighting and viewing distance while creating the environment, including signage, pictograms.
- In case when information transfer is based on colour recognition, colour should additionally be duplicated with the shape.
- Anti-glare options, installation of blinds and other solutions that prevent direct sunlight should be provided.
- Visual contrasts should be taken into account when creating the environment and colours of surfaces (like floors, ceilings, stairs), objects (furniture, handrails, benches etc) and dangerous obstacles need to be marked (like changes in surface levels and stair steps).
- Installation of tactile patterns on the floor – warning lanes, guideline for the blind.
- Introduction of assistive technologies.

PEOPLE WITH ALLERGIES

- Materials, colours, plants that do not cause allergies should be used.
- Avoiding accumulation of dust.
- Adequate ventilation should be provided.
- Areas should be provided where the chances of allergic reactions are reduced – non-smoking areas, areas where pets are not allowed.

HEARING DISORDERS

- Different ways of transferring information, using visuals – text, pictograms, subtitles (also for video materials).
- Sufficient space should be provided to allow the use of sign language.
- Background noise (e.g., commercials, music) should be limited as much as possible.
- The environment should be created in a way to suppress surrounding background noise to ensure clear reception of audio information, clear audibility, reduction of sound reflection.
- Introduction of assistive technologies, e.g. induction loops.

PEOPLE WITH COGNITIVE DISABILITIES

- A clear, logical path to the necessary premises, such as reception, toilet, elevator etc. Important points must be marked visually and with internationally well-know and easy-to-understand signs or pictograms.
- Easy, intuitively understandable movement and evacuation routes.
- Intuitively comprehensible use of doors and equipment should be provided, e.g., to clearly understand whether the door is hinged, sliding or opens automatically.
- Signs with pictograms, internationally well-know and easy-to-understand direction signs should be provided.
- Quiet waiting areas should be available, e.g., for people with autism spectrum disorders.

PEOPLE WITH MOVEMENT DISORDERS, LIMITED RANGE OF MOVEMENTS AND LIMITED MOBILITY

- A clear, logical path to the necessary premises, such as reception, toilet, elevator etc.
- Easy, intuitively understandable movement and evacuation routes.
- Sufficient turning radius should be provided for people using technical aids (e.g. wheelchair).
- Appropriate changing areas should be provided. E.g. a narrow corridor or sidewalk has a wider place to exchange when driving a baby carriage or a wheelchair.
- Adequate access to equipment (e.g. ticket machine, information screens) should be provided for people from a seating position or for short-statured people.
- Anti-glare in signs and screens should be ensured from different viewing angles, e.g., so that the screen is clearly visible from a sitting position.
- Access to equipment should be provided at two heights: from a sitting and standing position.
- Entrances and passageways should be provided without steps, stairs, e.g., by using ramps.
- The need to use effort should be reduced as much as possible, e.g., when opening a door.
- Easy-to-use switches, door locking and opening mechanisms should be provided so that they can be used by a person, e.g., without hands etc.
- Support handles and handrails should be provided, e.g., for stairs, ramps, toilets etc.
- Non-slip surfaces should be provided.

Access to the building - guest house, cafe etc.

Entrance into the building without obstacles, e.g., alternative path/route or lift, ramp (height-length proportion not more than 1:12 (8%), width 1,20m, railing at two heights 70cm and 90cm)

Parking lot for people with disabilities



Easy orientation

Max distance from the ramp 50 m

Easy access road/path to the building

Interest objects - museums, science centres, exposition halls etc.

Entrance

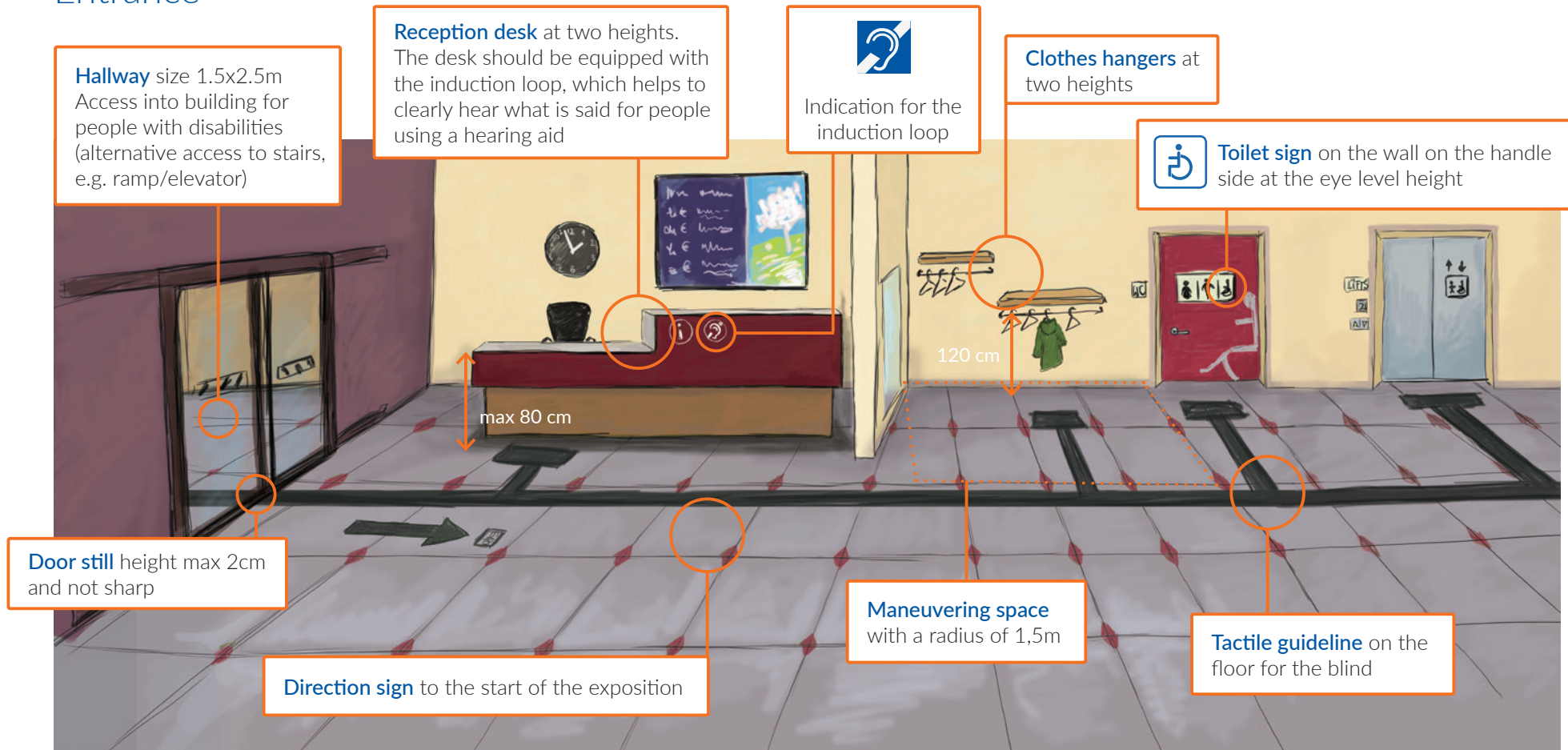

Lighting

The light must not dazzle, it should be diffused or positioned so that the bulbs do not shine directly into the eyes.

- On the floor **100 lux**
- On the stairs, in places with a change of levels **150 lux**
- For reading texts **300 lux**
- In public spaces indoors **200 lux**



Contrasts

Exhibits, demarcating barriers, level changes, door stills should be visually noticeable, contrasting. Contrasts should be tonal dark on light, for example white and black. Poor contrast is, for example, light gray and yellow.



Signs

It is recommended to place direction signs near the object and in it - from the parking lot to the entrance, to the toilet, wardrobe, start of the exhibition etc.



Website

It is recommended to create an accessibility section on the website with a description of what is accessible, partially accessible, not accessible at the object. A description is also suggested (including in audio format for people with visual impairments) on how to get to the object from the nearest public transport stop and parking lot.

Doors
Doors in toilets must open outwards and **have a free opening space of 90 cm**. The door lock handle should be easy to grip and turn. To close the door more easily, an additional handle is needed on the hinge side from the interior

Sink
The sink must be firmly fixed so that a person can lean on it. **The height of the sink should be 80 cm**, and there should be free space under it. The mirror should be placed so that a person can see himself while sitting. The lower edge of the mirror should be no higher than 90 cm from the floor

Handles
The handles on the toilet bowl must be well secured, **the load capacity of each handle must be at least 70 kg**. It is very important to follow the correct placement of the handles (see sketch)

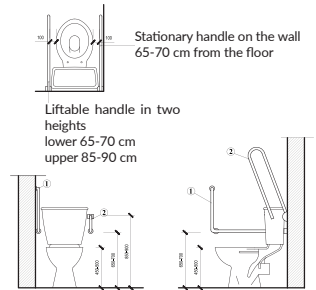

Bag hook
A hook **should be provided to hang a bag, jacket/coat, cane, crutch**. In order to be usable by people in wheelchairs, it should be placed lower than usual, at a height of 100 - 120 cm from the floor. Also it is recommended to use 2 hooks

Wastebin
Cannot be opened with foot, but **needs to be open top**

Baby changing table
The baby changing table should be placed as close as possible to the sink. The table **must be at least 70x100 cm in size** and placed at a **height of 80-85 cm from the floor**

Seat transfer zone
When planning the placement of sanitary equipment, it is important to note that a **seat transfer area should be provided near the toilet bowl**. This area must be free from other equipment, such as a sink, trash can, or any other obstacle

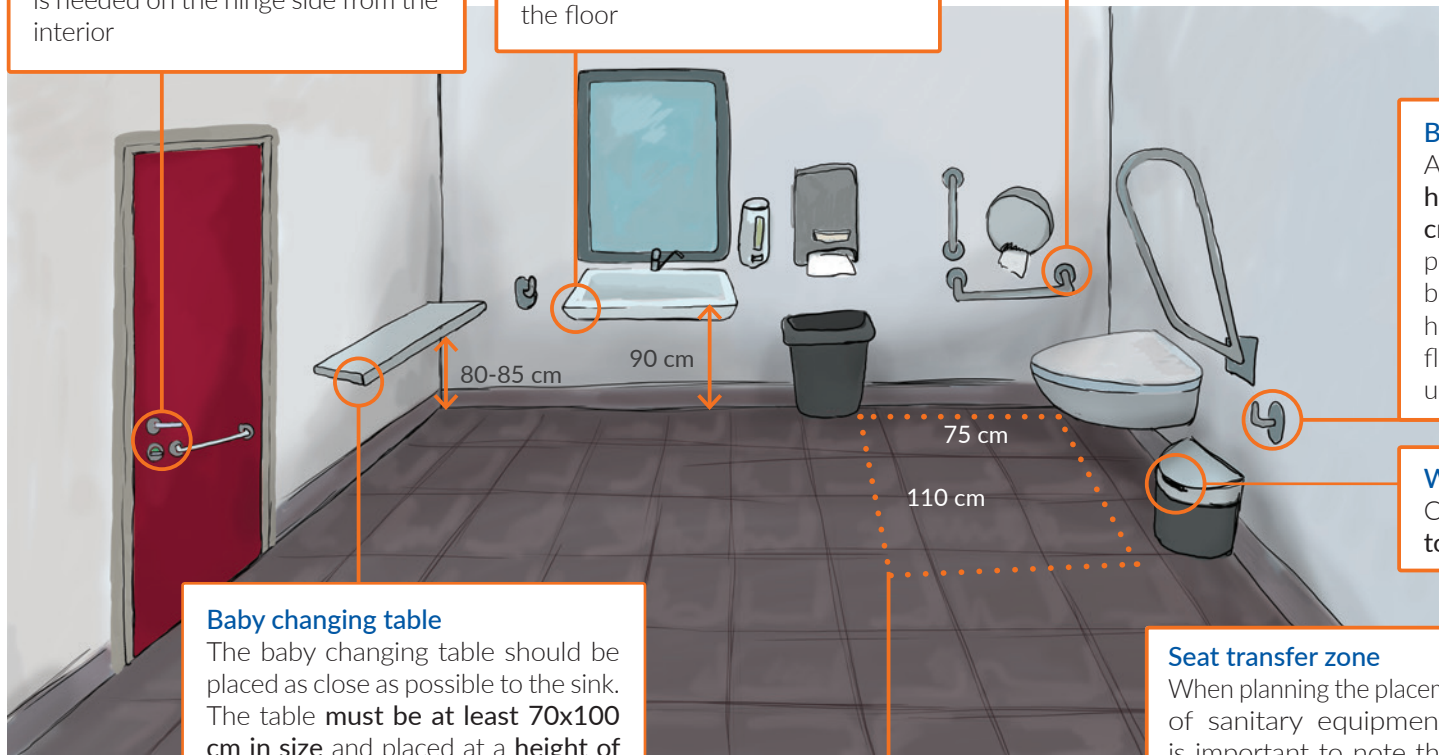
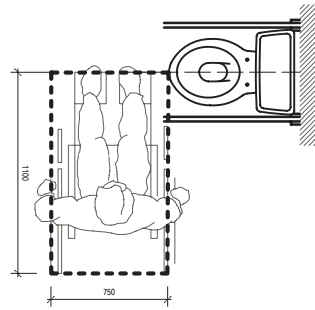

Low aisles (up to 210 cm) should be marked with a warning on the floor and the top of the aisle. The marking should be made in such a way that it stands out, but does not “jump out” from the overall design of the room

Paintings
Paintings, photographs and other images should be placed in such a way that a **person can come closer** to them and study the image. The image should be placed within 80 cm - 200 cm from the floor. It is preferable to place the descriptions next to the pictures, within 120-160 cm

Showcases
Exhibits should preferably be placed at a height of **80 cm - 200 cm from the floor**. It is desirable to provide a place - indentation - so that a wheelchair user can drive under and see the exhibits closer

Interactive stand
It is easier for people with poor vision to perceive text in dark mode, i.e. dark background and light letters. The dark mode does not mean only black and white, it is necessary to use dark colors of different tonalities to group sections and make information easy to understand. It is also recommended to incorporate **the function of changing the font size and magnifying glass** to allow a more detailed view of the text and images. Blind people need to be provided with audio information. Deaf people should be provided with subtitles in video reels and the possibility to receive information in sign language

Statue
If the object is not allowed or, for example, cannot be touched due to its size, a 3D copy can be made of it on a smaller scale. **The model should not have sharp edges and should be made of durable, easy-to-clean material**

Inclined stand
The stand should also be easy to use for people in wheelchairs and children, so it should be **placed at an angle of about 30 degrees with the height of the lower edge from the floor 80 cm**, so that it can be easily accessed by children and people in wheelchairs, incl. driving under the stand (free space under the stand should be at 75 cm height from the floor and at 40 cm depth)

For **horizontal showcases**, it is preferable to place the exhibits at a depth of 60 cm. If the showcase is wider, access from both sides should be provided

Vertical stand
Vertical interactive stands should provide for the possibility to switch the screen so that its **control is also accessible to people from wheelchairs or children**. The reachable height is from 60 cm to 120 cm

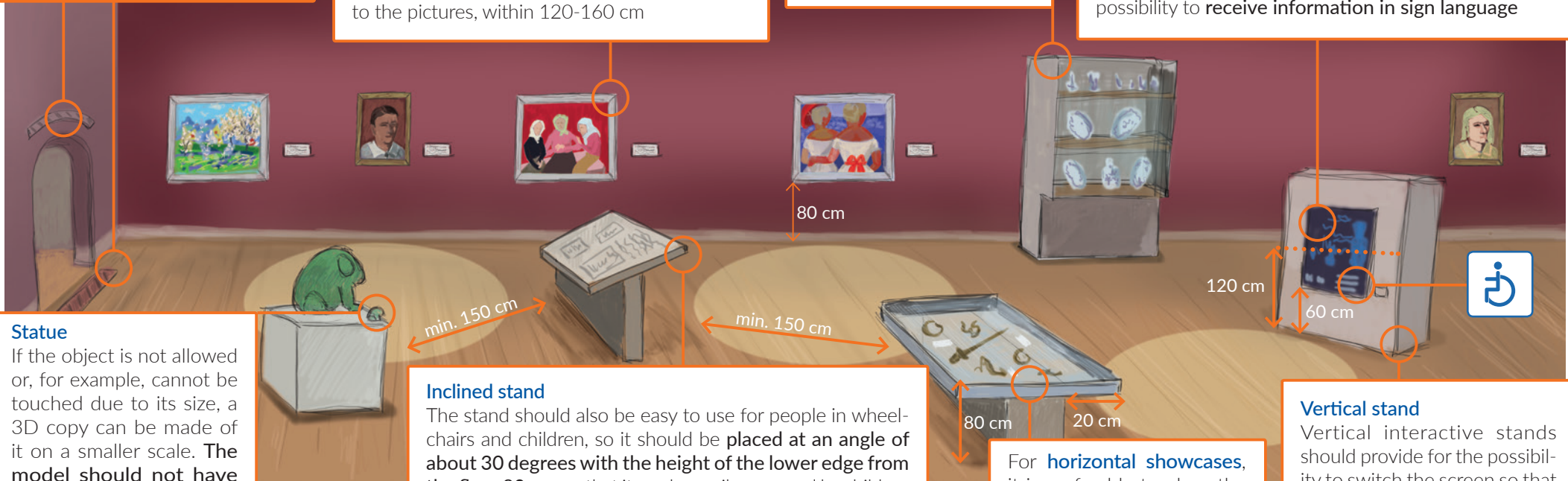

 **Braille script**

Is different in each language, so it is recommended to duplicate the written text in audio format using, for example, a QR code

 **Use of accessible translations**

Subtitles, sign language, audio descriptions in video materials/events, easy to read, short texts

 **Printed materials**

Should be at least of 14 font size, text should contrast on a non-reflective background material

Personnel is aware of disability needs, incl. different disability types, e.g. wheelchair users, people with visual impairment (white canes, **guide-dogs** (might also assist wheelchair users)), cognitive impairment, hearing impairment etc.

If **the menu** is posted on the wall, it **must be duplicated printed on a page** in at least one copy that can be taken in hand

 **Toilet** for people with disabilities

Good practice is to offer clients the **reading glasses**, to see menu if glasses are forgotten

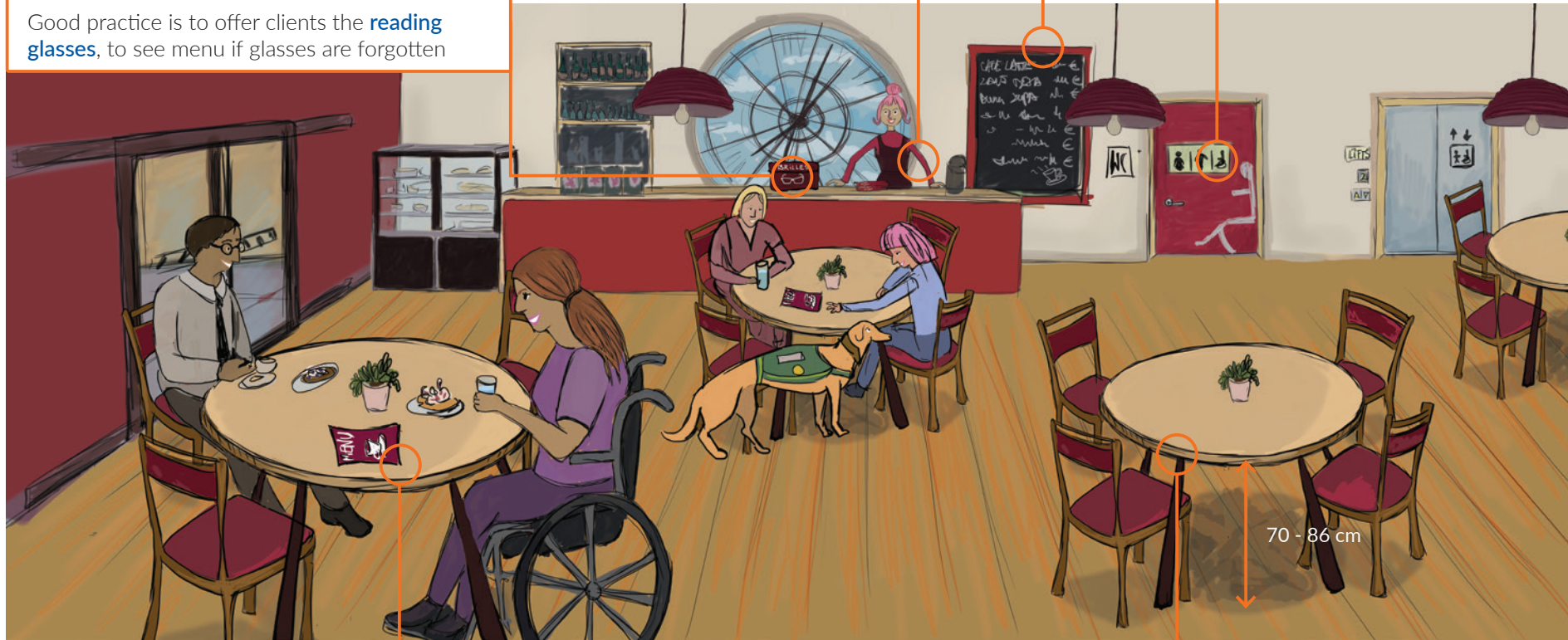

Accessible menu, flexibility regarding clients' dietary restrictions. One menu should be **provided in an enlarged print** with strong text contrast

Access to the service - in order for a person in a wheelchair to be able to easily access the table, it should have the **free space under the table of 70 cm from the floor**

Entertainment - concert hall, cinema, theater



Indication for the
induction loop

Access to services, e.g., subtitles, sign
language translator etc..

Toilet for people with disabilities

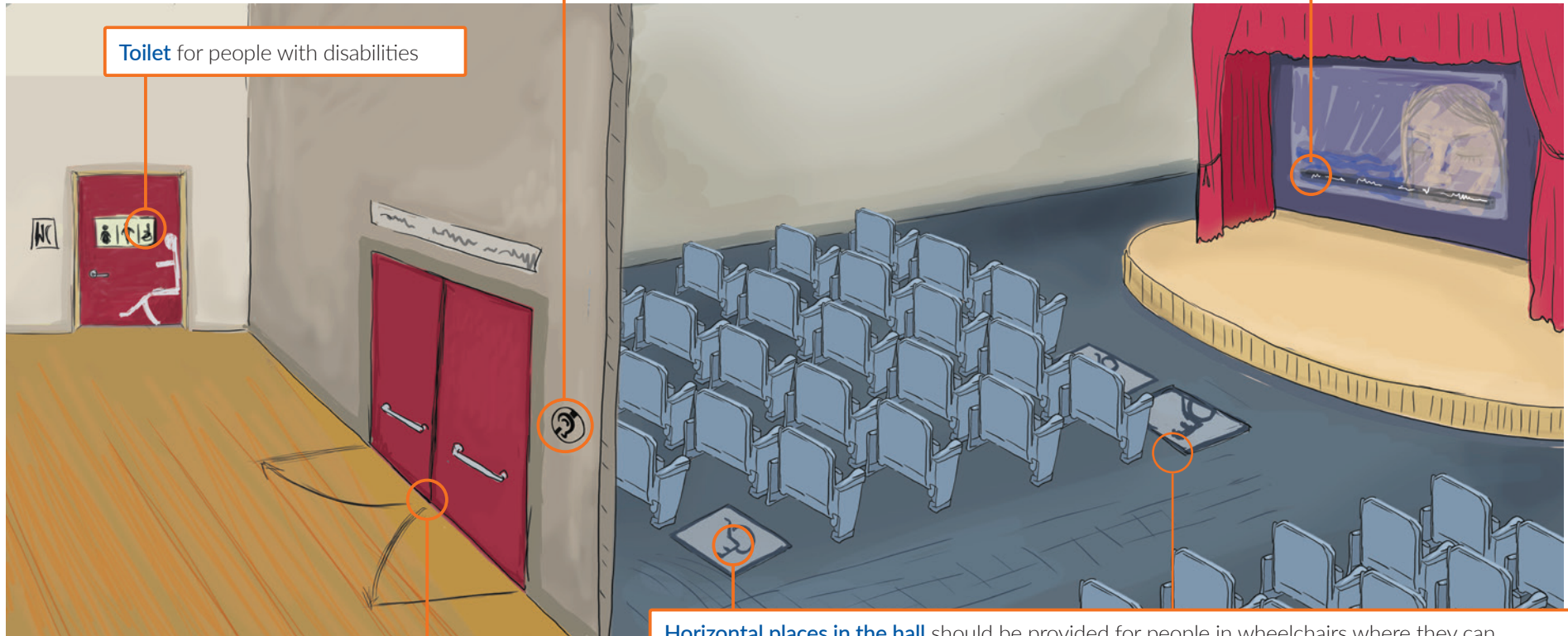

Easy access, door still height max 2 cm and not sharp. Marking
for the opening direction of the doors

Horizontal places in the hall should be provided for people in wheelchairs where they can comfortably settle down with their wheelchairs. A person should be able to choose at what distance to sit from the stage or the screen, therefore one place can be foreseen in the first row and one place in the last. Best practice is that the middle part of the hall has one row removed to provide more space for wheelchairs, guide-dogs etc., i.e. the seats are removable, so they can be removed or put back, depending on the need. It should be remembered that a person most often comes with someone and wants to sit next to each other, therefore a place in a wheelchair should be provided next to the seat.

Access to performance (content), vendatory machines, (e.g. coffee), services, e.g., wardrobe, toilet, personnel has knowledge about the needs of people with disabilities, incl. different disability types. The room has to be equipped with the induction loop and an indication sign of the induction loop should be provided

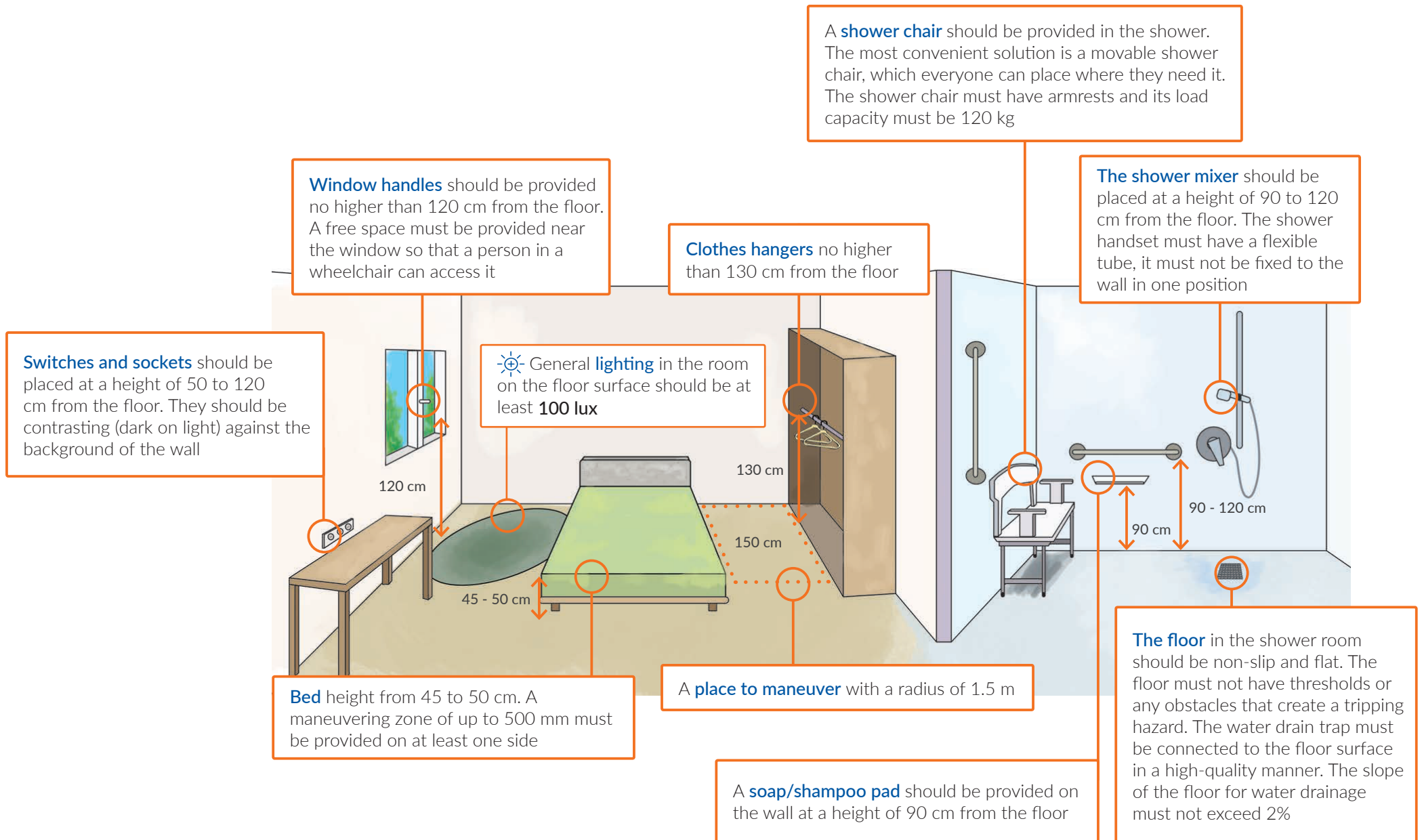



The Guidelines have been prepared with the support of the Interreg Estonia-Latvia Programme 2021-2027 under the Project No.EE-LV00043 “Development of Accessible Tourism Routes” (Access Routes).

The aim of the project is the development of tourist routes in Latvia and Estonia accessible to people with disabilities. The project is implemented by the Kurzeme Planning Region in cooperation with the Vidzeme Planning Region, Estonian Chamber of People with Disabilities, Development Centre of Võru County, Tartu County Tourism Foundation – Lõuna-Eesti DMO.

In addition to these Guidelines, over the 2,5 years project period the partners will carry out a number of accessibility inspections for nature trails, cultural heritage and other objects, record audios with QR codes for trails and objects, develop accessible routes and invest in the physical accessibility of objects (5 in Kurzeme, 7 in Vidzeme and 9 in Estonia) – by creating innovative tactile solutions, develop nature/culture interpretation solutions (e.g. chests of senses) for individual use by people with disabilities, organise accessibility days in Latvia and Estonia, publish accessible objects and routes on www.mapeirons.eu, create a “Disability friendly” brand, mark the route objects, issue a Travel Guide and organise a digital marketing campaign.

More about the project: www.kurzemesregions.lv/projects/

Project financing from the European Regional Development Fund (ERDF):

894 574,00 EUR

Project partners’ co-financing:

223 643,50 EUR

Interreg



**Co-funded by
the European Union**

Estonia – Latvia



**KURZEMES
PLĀNOŠANAS
REĢIONS**



NGO “Apeirons” and Kurzeme Planning Region are fully responsible for the content of the Guidelines, and under no circumstances can it be considered the official position of the European Union.